

S-4

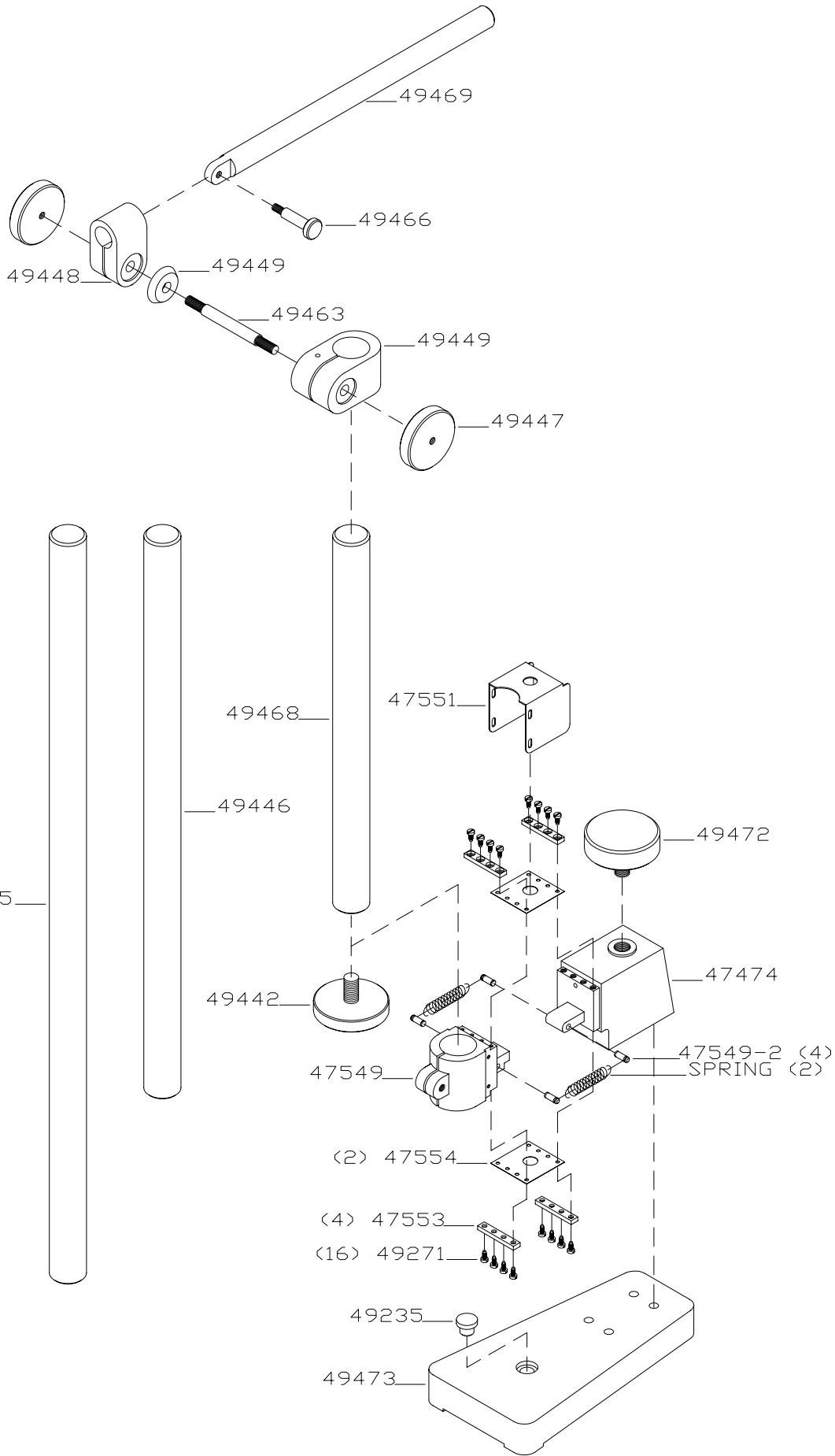
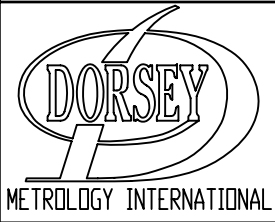

REV: 4/24/2008
FILE: S-4 ASSY.dwg