

DBM-1200

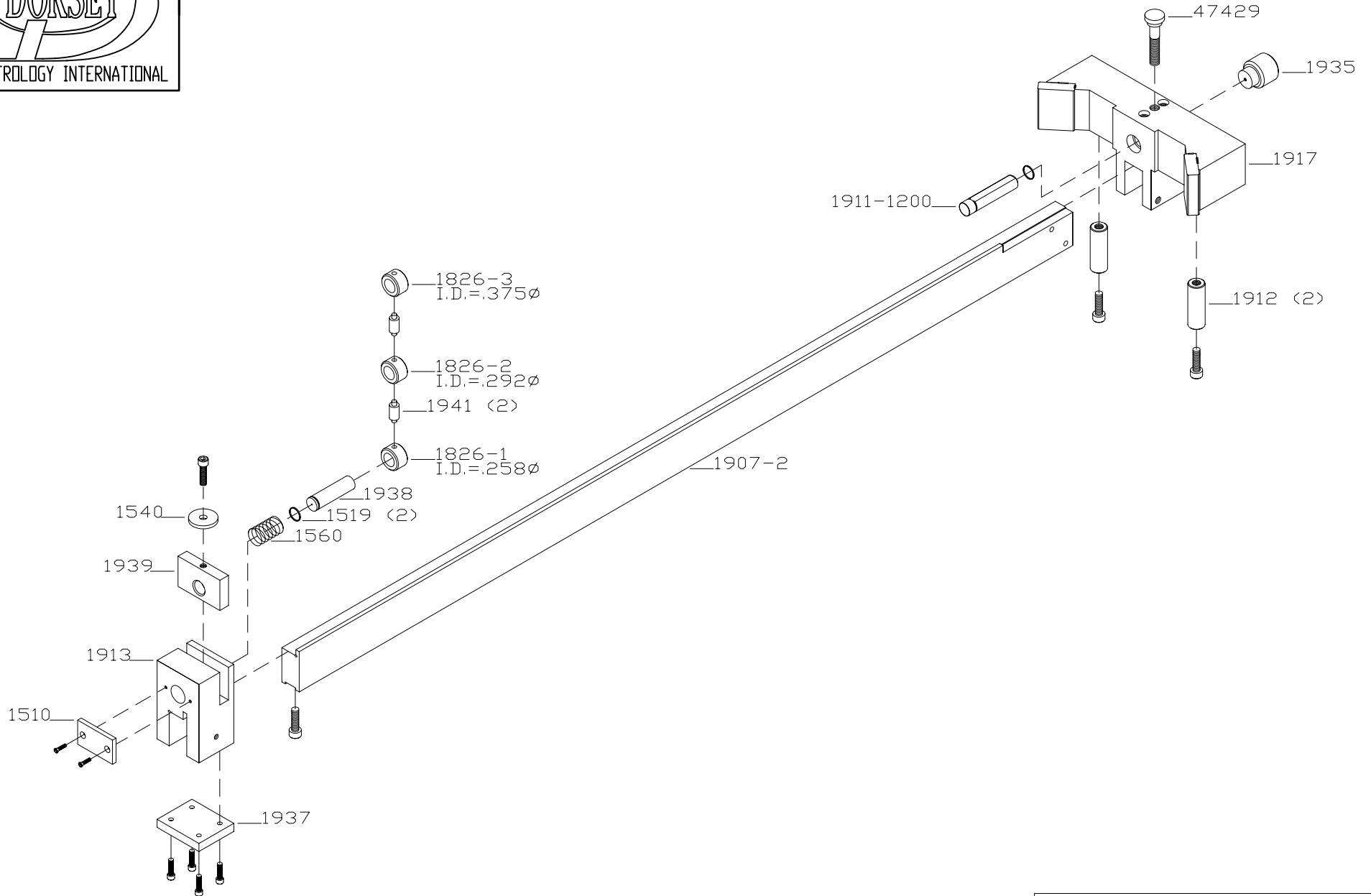
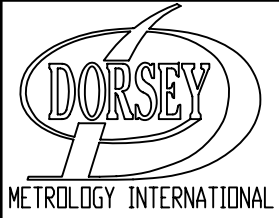

REV: 5-30-08
FILE:DBM-1200 ASSY.dwg